

BRIDGE LANE

HOME & GARDEN

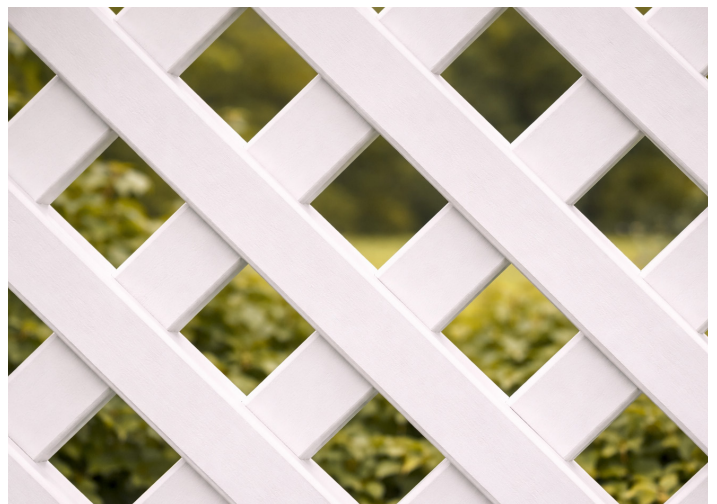

Wellington Tri-Screen



Wellington Tri-Screen

HEIGHT

4'

WIDTH

9'8" / 11'8" / 12'8"

MATERIAL

Made from eco-conscious, advanced recycled PVC with internal Aluminum Reinforcement.

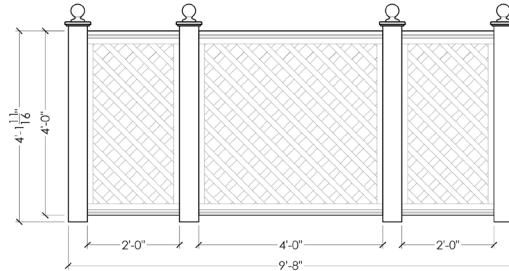

COLOR



Ebony



Charcoal



BLHG Green



Moss



Mist



Shell



Slate



Parchment

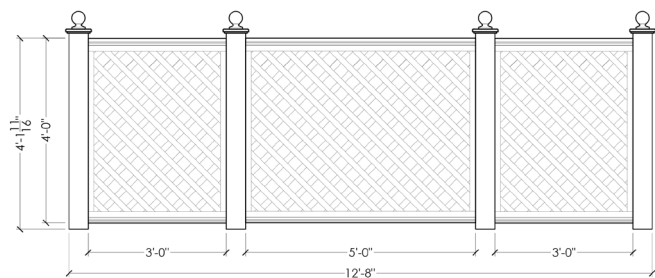
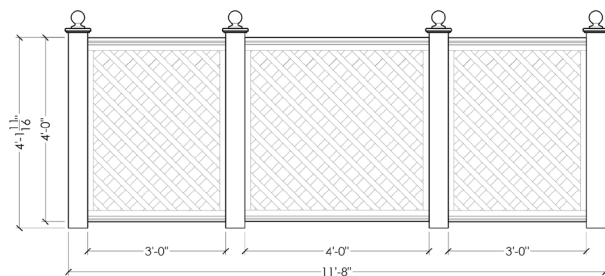

FINIALS



Wellington Tri-Screen Combinations

U CONFIGURATION

Use the tri-screen for any "U" configuration

ADD RETURNS

2'W Returns

3'W Returns

MATERIAL

Made from eco-conscious, advanced recycled PVC with internal Aluminum Reinforcement.

COLOR



Ebony



Charcoal



BLHG Green



Moss



Mist



Shell



Slate



Parchment

FINIALS

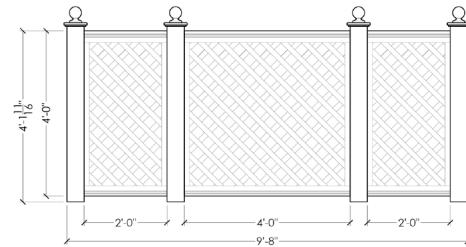

FRONT

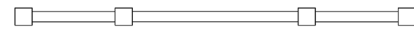

PLAN - STRAIGHT CONFIGURATION



PLAN - U CONFIGURATION (RETURNS)

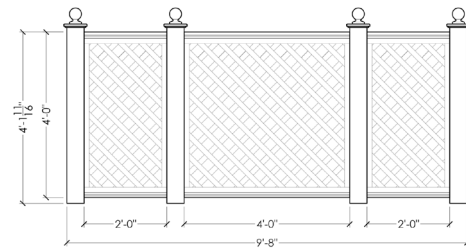

FRONT

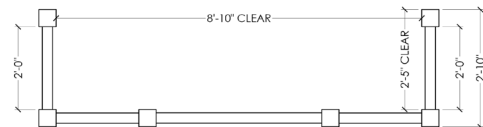

PLAN

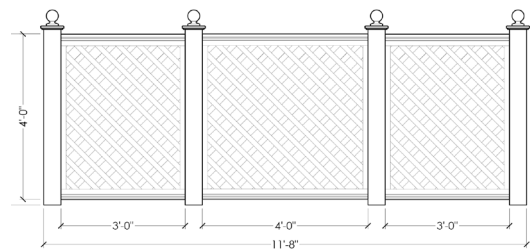

FRONT

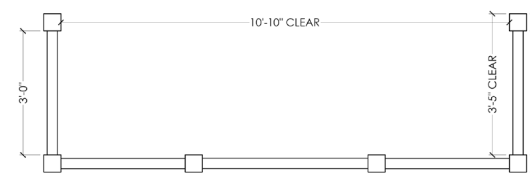

PLAN

Installation Instructions

INSTALLATION SCHEMATIC Posts Set in Ground

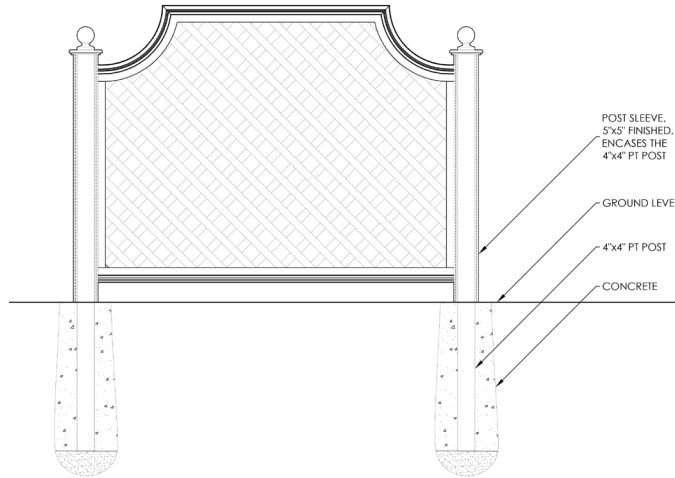

INSTALLATION SCHEMATIC Posts Surface-Mounted to Deck

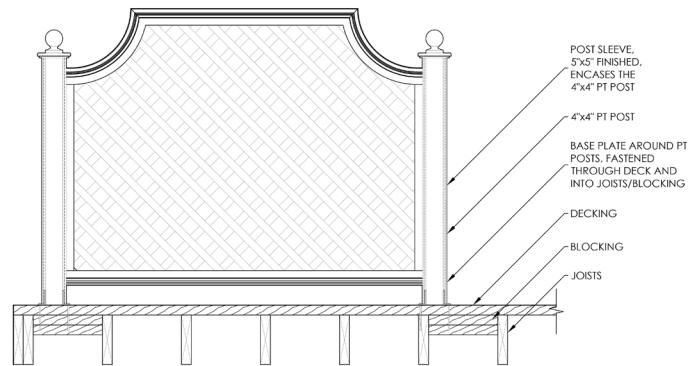

INSTALLATION SCHEMATIC Aluminum Patio Stand

