

# BRIDGE LANE

HOME & GARDEN

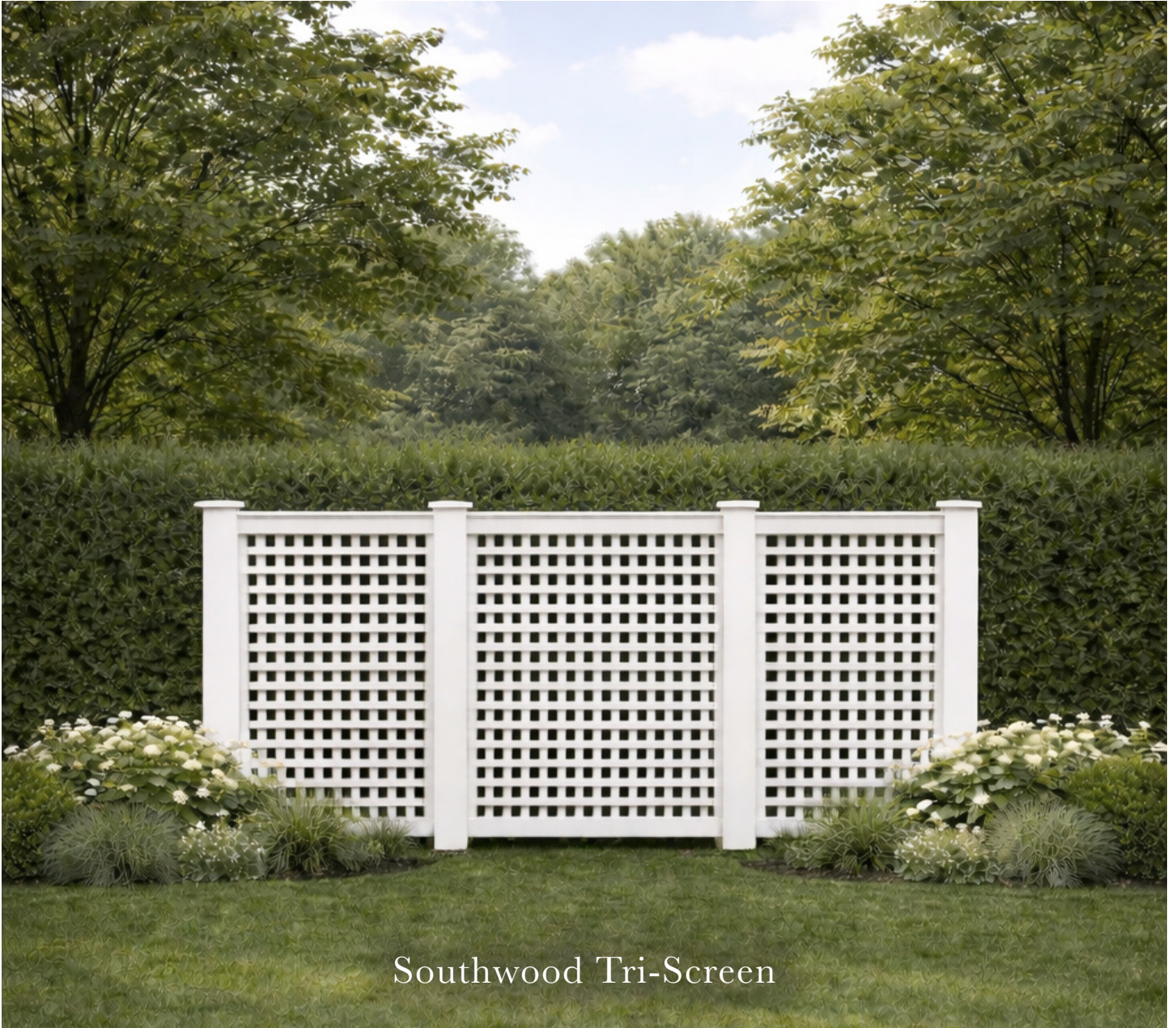

Southwood Tri-Screen



# Southwood Tri-Screen

## HEIGHT

4'

## WIDTH

9'8" / 11'8" / 12'8"

## MATERIAL

Made from eco-conscious, advanced recycled PVC with internal Aluminum Reinforcement.

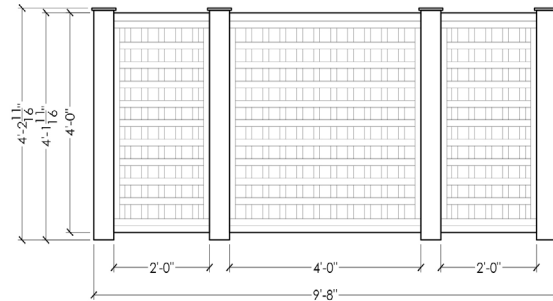

## COLOR



Ebony



Charcoal



BLHG Green



Moss



Mist



Shell



Slate



Parchment

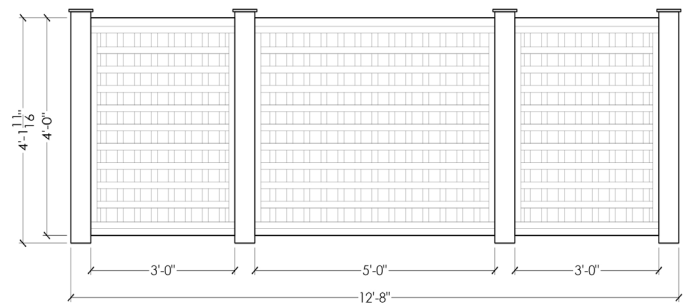
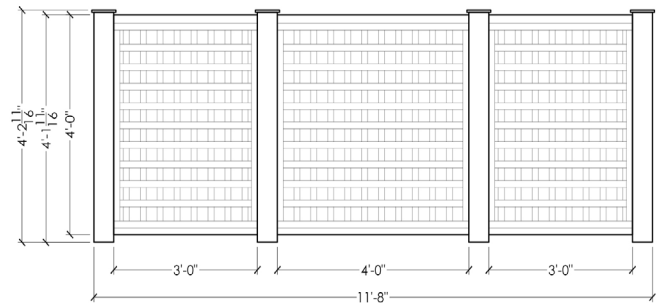

## FINIALS

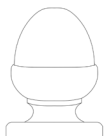

# Southwood Tri-Screen Combinations

## U CONFIGURATION

Use the tri-screen for any "U" configuration

## ADD RETURNS

2'W Returns

3'W Returns

## MATERIAL

Made from eco-conscious, advanced recycled PVC with internal Aluminum Reinforcement.

## COLOR



Ebony



Charcoal



BLHG Green



Moss



Mist



Shell



Slate



Parchment

## FINIALS

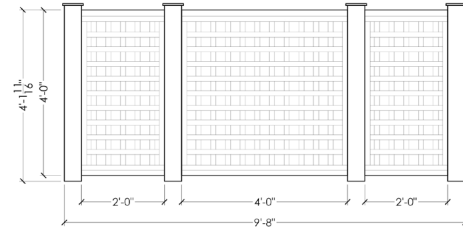
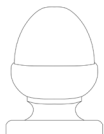

FRONT

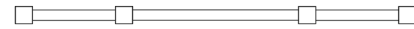

PLAN - STRAIGHT CONFIGURATION



PLAN - U' CONFIGURATION (RETURNS)

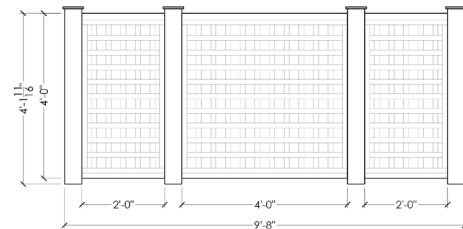

FRONT

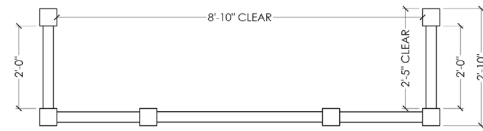

PLAN

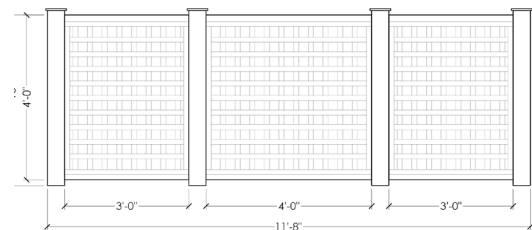

FRONT

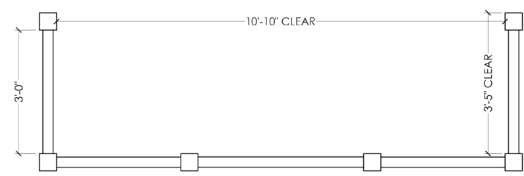

PLAN

# Installation Instructions

## INSTALLATION SCHEMATIC Posts Set in Ground

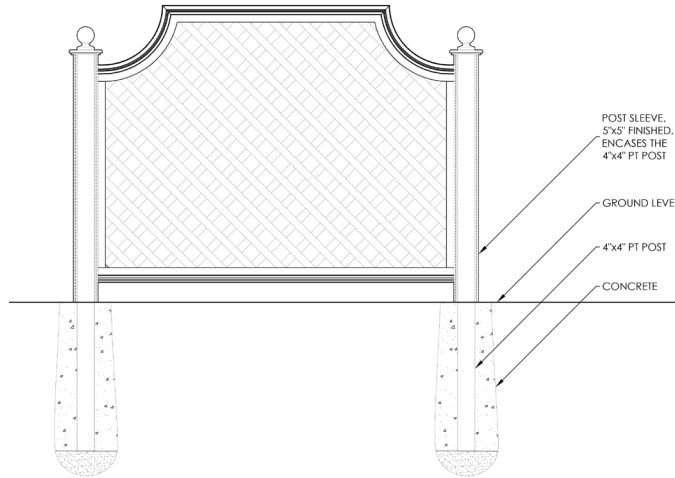

## INSTALLATION SCHEMATIC Posts Surface-Mounted to Deck

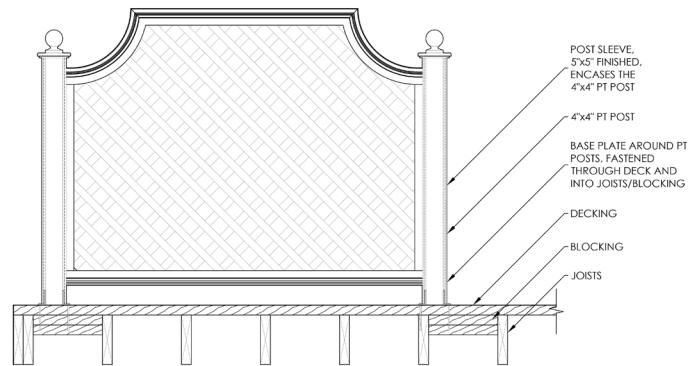

## INSTALLATION SCHEMATIC Aluminum Patio Stand

