

# BRIDGE LANE

HOME & GARDEN



Southwood Treillage Screen



# Southwood Treillage Screen

Starting at \$9,200

## HEIGHT

Standard 5'6"

## WIDTH

8'8"

9'8"

11'8"

12'8"

## MATERIAL

Made from eco-conscious, advanced recycled PVC with internal Aluminum Reinforcement.

## COLOR



Ebony



Charcoal



BLHG Green



Moss



Mist



Shell



Slate



Parchment

## FINIALS

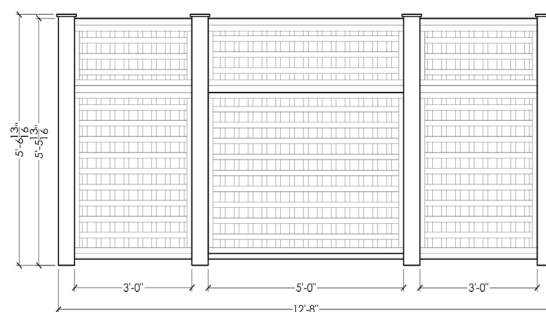
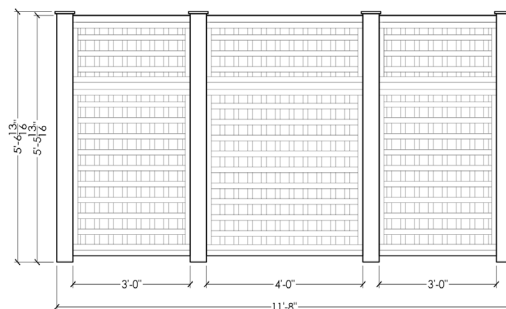
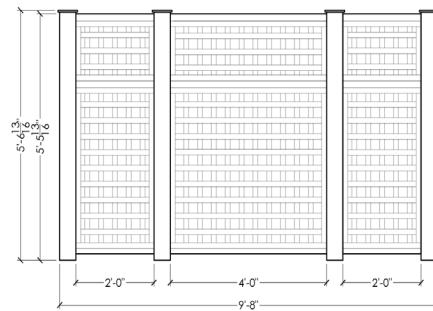
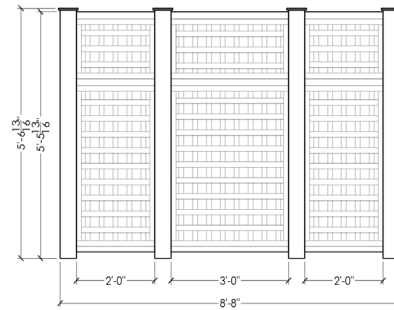

# Southwood Treillage Screen

Starting at \$11,000

## HEIGHT

Grand 7'6"

## WIDTH

8'8"

9'8"

11'8"

12'8"

## MATERIAL

Made from eco-conscious, advanced recycled PVC with internal Aluminum Reinforcement.

## COLOR



Ebony



Charcoal



BLHG Green



Moss



Mist



Shell



Slate



Parchment

## FINIALS

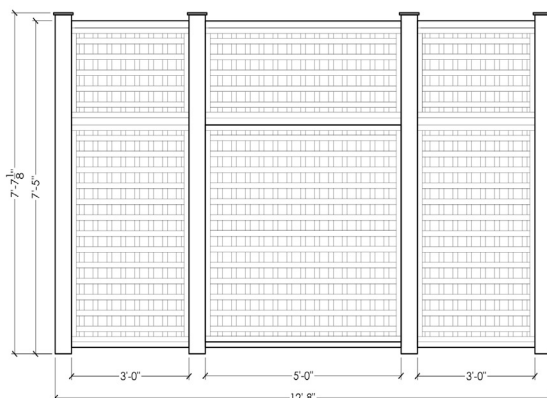
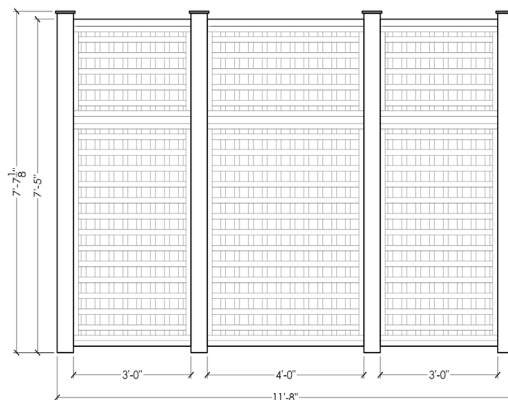
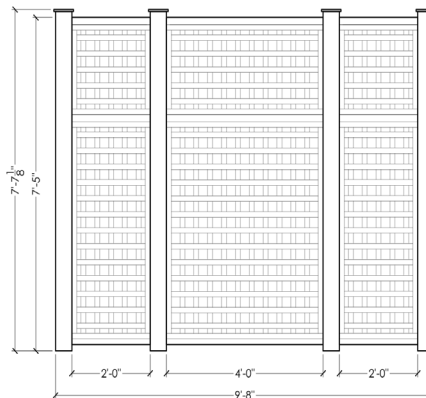
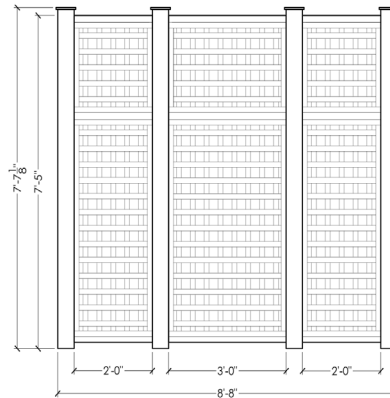

# Southwood Treillage Screen

## HEIGHT

Standard 5'6"

Grand 7'6"

Monumental 7'6"

## WIDTH

Build your ideal width  
with modular components

## MATERIAL

Made from eco-conscious,  
advanced recycled PVC  
with internal Aluminum  
Reinforcement.

## COLOR



Ebony



Charcoal



BLHG Green



Moss



Mist



Shell



Slate



Parchment

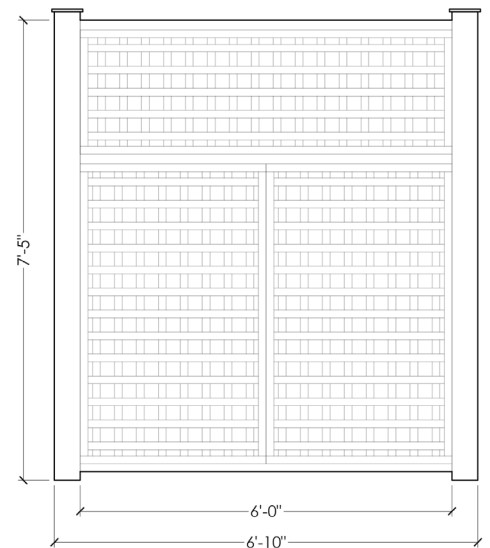
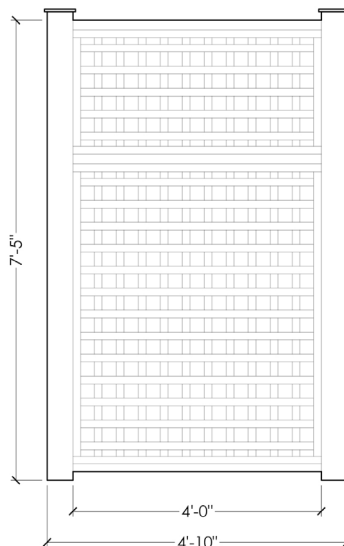
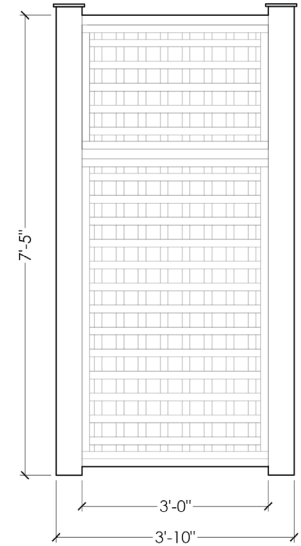
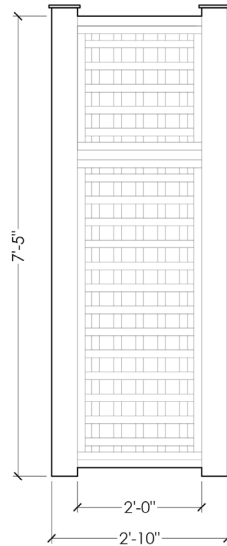

## FINIALS



# Installation Instructions

## INSTALLATION SCHEMATIC Posts Set in Ground

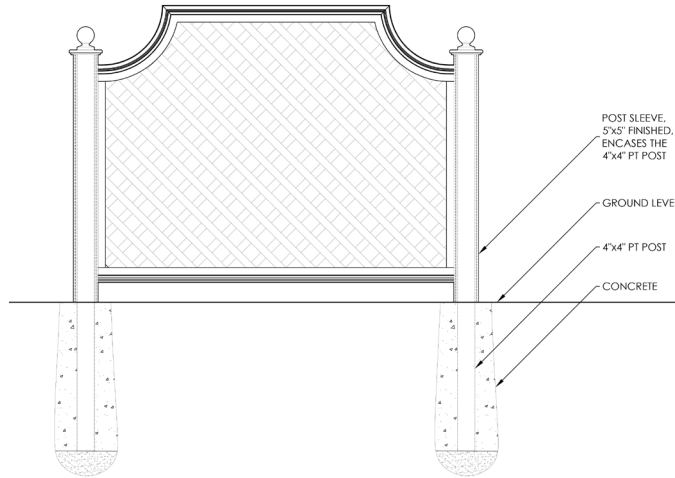

## INSTALLATION SCHEMATIC Posts Surface-Mounted to Deck

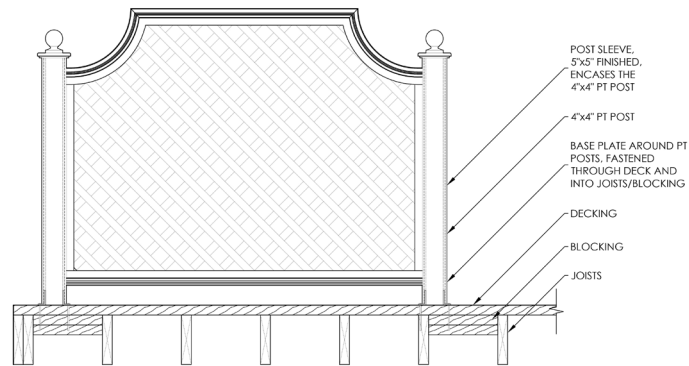

## INSTALLATION SCHEMATIC Aluminum Patio Stand

